

Arbiton
FLOOR EXPERT

2022

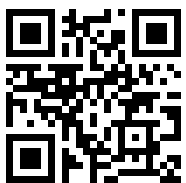

www.arbiton.com

SKIRTING BOARDS

MORE THAN... **JUST SKIRTING BOARDS**



WE CREATE

WE TEST

WE PRODUCE

Innovation, quality and know-how. Since 1994 we've been investing in knowledge, technology and our machinery park.

We aim to become market LEADER wherever we are present. We push forward and strive for more to deliver accessories perfectly matched to the products.

**WE TRY HARDER, WE ARE
THE FLOOR EXPERT**





TECHNOLOGY

Our inhouse laboratory is testing hundreds of floors from all major manufacturers to improve our accessories and create a functional flooring system. That's why we know the strongest and weakest points of all types of floors. We also test our underlays to deliver top quality solutions for different floor types.

DESIGN

Every year A.DESIGN STUDIO analyzes trends, changes in consumer preferences and hundreds of new floor colors. That's why we can create customer orientated solutions and stay relevant.

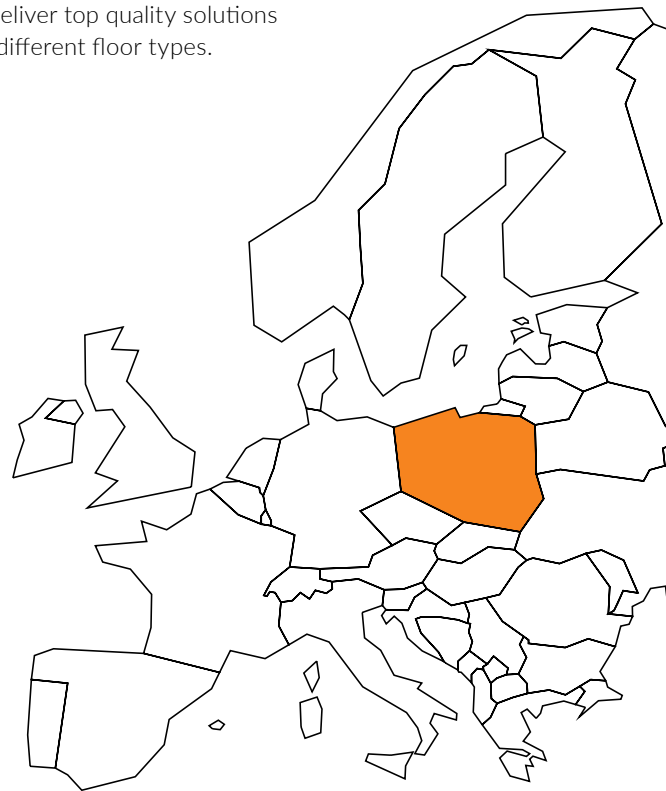

MANUFACTURE

We are an European leader for production of floor accessories. Our technological development allows us to offer great portfolio of products in various technologies.

TORE | 05 Black



TORE | 01 White



NEW COLLECTIONS

We do not limit ourselves and stop pushing towards innovation. That is what drives us to create new products. Initially we have set an ambitious goal for our new skirting board.

5 new colors

NEW

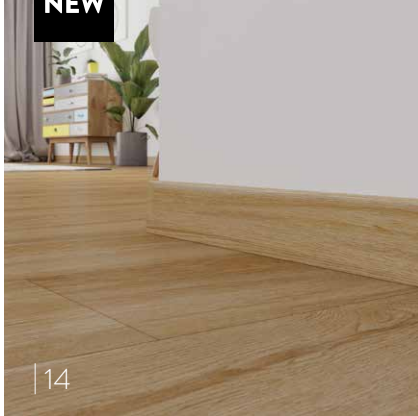

| 14

TORE ●

NEW



| 14

TORE MONOCOLOR ●

2 new colors

8 new colors

NEW



| 20

VIGO 60 ●

NEW

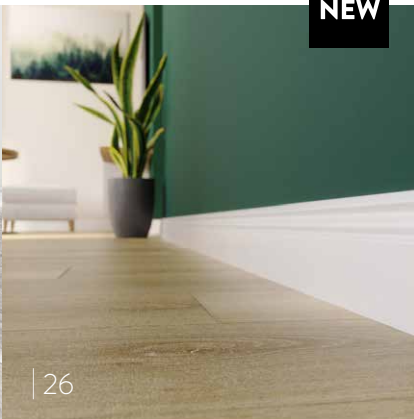

| 26

STIQ XL ●



| 30

NEW

STIQ+ ●

TABLE OF CONTENT



SOLID CORE



INDO ●

LARS ●

MACK ●



MODERN PVC

LM60 ●

LM55 ●



TRADITIONAL PVC

PAINT-IT ●

DIAMOND ●



TRADITIONAL MDF

UNIVERSAL PROFILES



ACCESSORIES

SKIRTING BOARDS

SOLID CORE
COLLECTIONS



HYBRID
TECHNOLOGY



**TORE
VIGO 60
VIGO 80**

**SOLID
CORE**

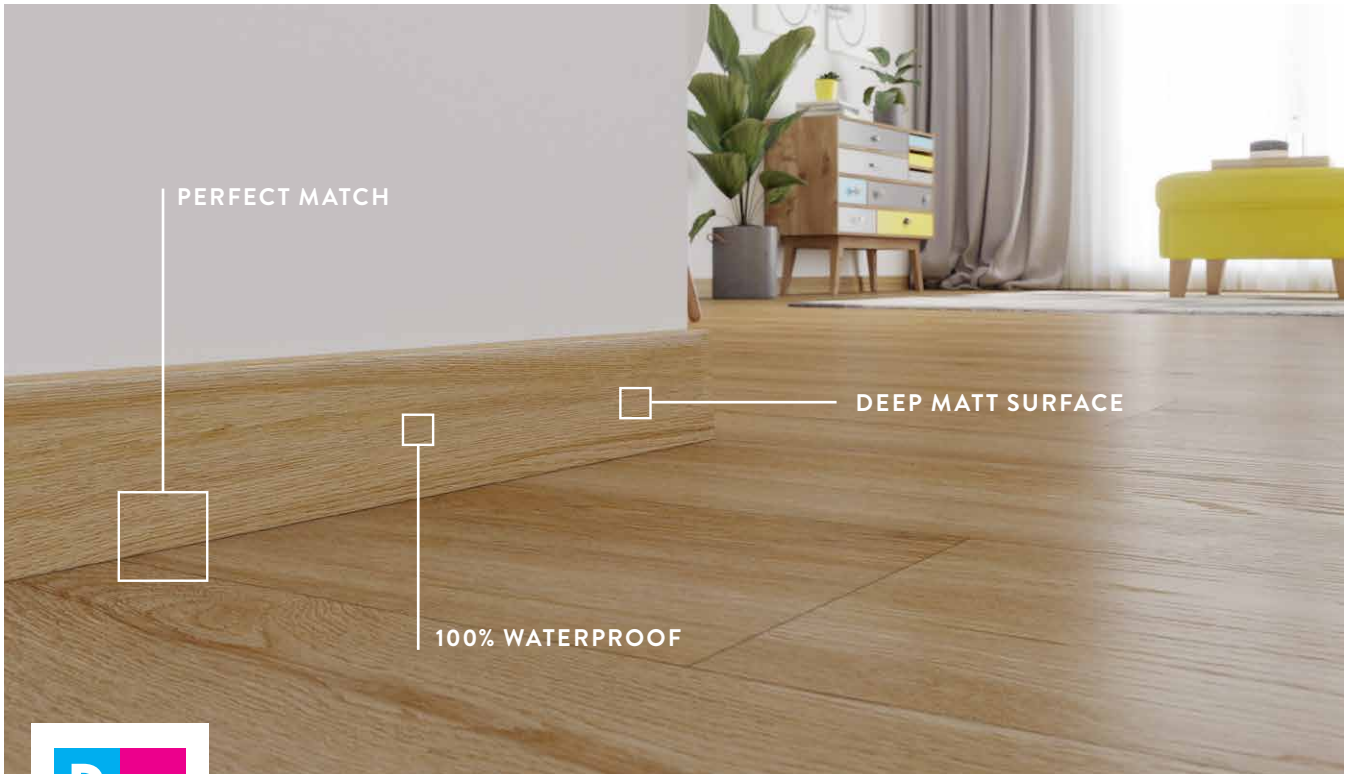

TORE

SOLID CORE SKIRTING BOARDS

TORE is our new hybrid skirting board produced in a brand new technology giving it a 100% water resistance as well as a higher abrasion resistance. Due to the highly advanced technology of digital printing - piezoelectric UV LED with high-resolution (up to 1800 dpi), we gained an unprecedented fidelity to raw materials at the surface of the skirtings boards, which now look like actual wood, stone or concrete. It allowed us to ideally match design of the skirtings not only with our floors but also with the most popular designs on the market.

With a multistep process of production TORE gains a perfect matte surface. As a result, skirtings boards obtain a deep thread design enriching each interior and underlining its beauty.

More importantly, used technologies provide the resistance to UV light - the design of the skirtings stays protected for years without discoloration and the colour remains as intensive as at the moment of installation. Except for the design, we also took care of the practicality. Due to the water resistance and matte surface, TORE is easy to clean. It will not be damaged in the process of scrubbing or vacuuming.

In addition, our product is environmentally safe. The printing technology is using the VOC Free and solvent-free inks and is eco-friendly. All these factors resulted in an excellent product which we are proud to share with you.

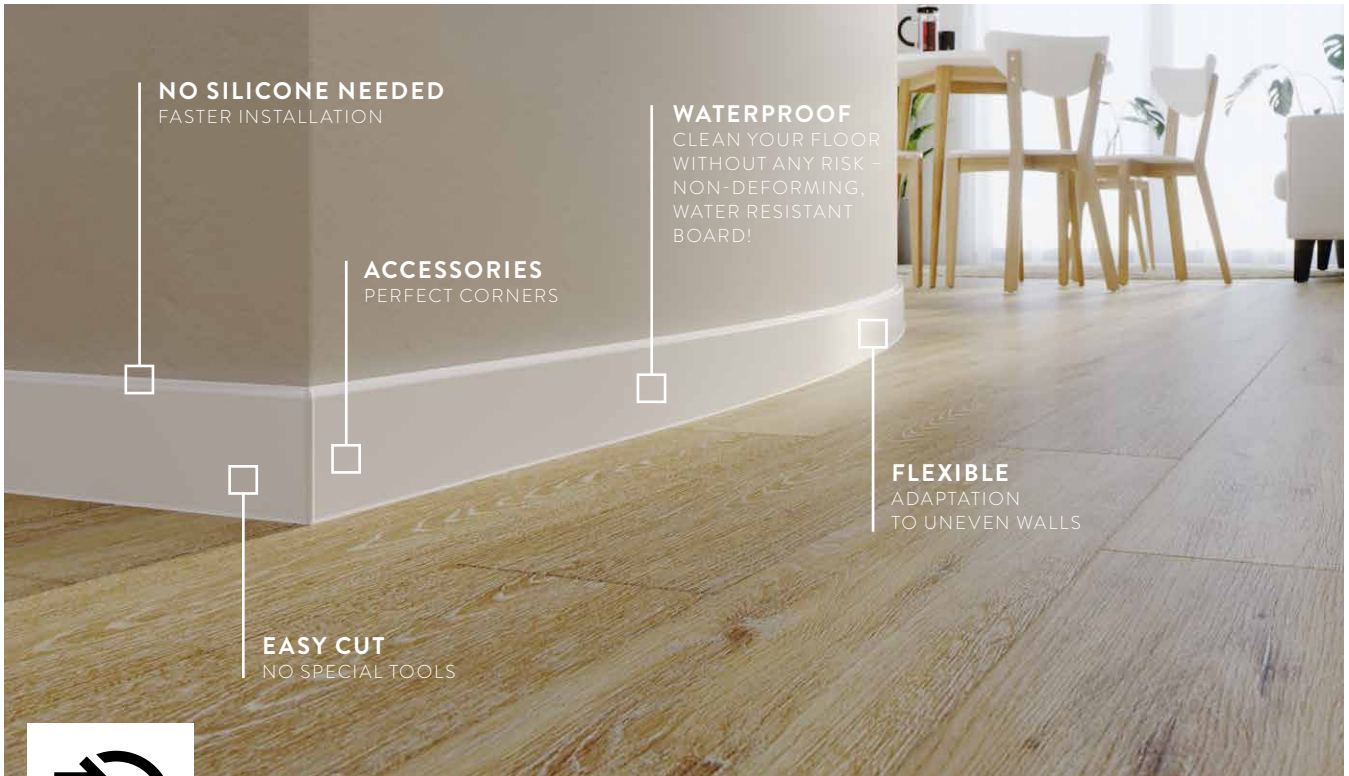

NO SILICONE NEEDED
FASTER INSTALLATION

WATERPROOF
CLEAN YOUR FLOOR
WITHOUT ANY RISK -
NON-DEFORMING,
WATER RESISTANT
BOARD!

ACCESSORIES
PERFECT CORNERS

FLEXIBLE
ADAPTATION
TO UNEVEN WALLS

EASY CUT
NO SPECIAL TOOLS



VIGO

SOLID CORE SKIRTING BOARDS

IT IS TIME TO END WITH DIFFICULT CHOICES. Thanks to our solutions we've created a skirting board in hybrid technology. Now, you have high quality surface of lacquered MDF skirtings and the flexibility and waterproofness of PVC skirtings.

What else? Easy assembly and dirt resistance. Thanks to the additional flexible and integrated seals, we have waterproof barrier on two sides - from the wall and from the floor.

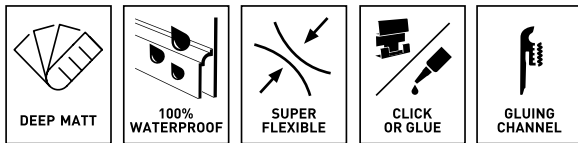

LET'S TAKE A STEP
INTO THE FUTURE.
LET'S VIGO

TORE MONOCOLOR

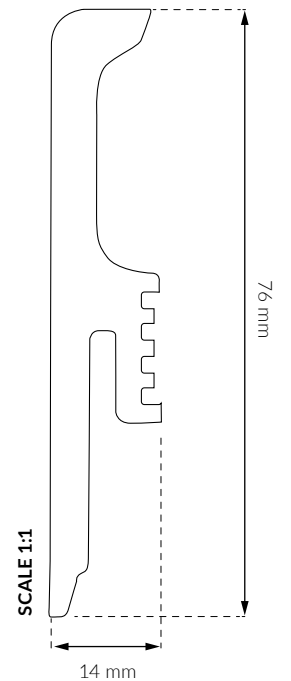

- SOLID CORE SKIRTING BOARD
- DEEP MATT SURFACE
- 100% WATERPROOF SKIRTING BOARDS
- FLEXIBLE CORE, PERFECT FOR ANY KIND OF WALL
- INSTALLATION WITH GLUE OR CLIPS
- GLUING CHANNEL



	SKIRTING	STRONGMAN GLUE	CLIPS AND DOWELS
	220 cm	-	ø 6 mm
	-	1 pc	20 pcs
	22 m	12 pcs	1200 pcs
EAN		5905167788264	5905167826737



01 | White (RAL 9003)

TORE 80 | 5905167845905



05 | Black (RAL 9011)

TORE 80 | 5905167845912



PROTECTIVE FOIL
Protective foil removable
after renovation



TORE

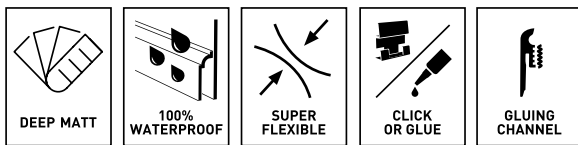

- SOLID CORE SKIRTING BOARD
- HIGH RESOLUTION WOOD DESIGN PRINTING
- DEEP MATT SURFACE
- 100% WATERPROOF SKIRTING BOARDS
- FLEXIBLE CORE, PERFECT FOR ANY KIND OF WALL
- INSTALLATION WITH GLUE OR CLIPS
- GLUING CHANNEL

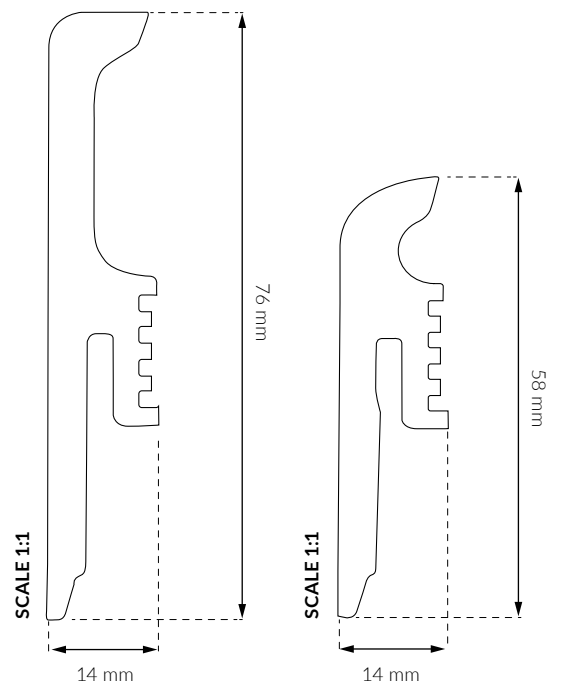

	SKIRTING	STRONGMAN GLUE	CLIPS AND DOWELS
cm /	220 cm	-	ø 6 mm
	-	1 pc	20 pcs
	22 m	12 pcs	1200 pcs
EAN		5905167788264	5905167826737



101 | Alaskan Oak

TORE 60 | 5905167835388
TORE 80 | 5905167835777



103 | Bergen Oak

TORE 60 | 5905167835395
TORE 80 | 5905167835784



104 | Canadian Oak

TORE 60 | 5905167835401
TORE 80 | 5905167835791



105 | Coney Oak

TORE 60 | 5905167835418
TORE 80 | 5905167835807



117 | Lahti Oak

TORE 60 | 5905167835531
TORE 80 | 5905167835920



112 | Bologna Oak

TORE 60 | 5905167835487
TORE 80 | 5905167835876



124 | Camden Oak

TORE 60 | 5905167835609
TORE 80 | 5905167835999



116 | Argos Oak

TORE 60 | 5905167835524
TORE 80 | 5905167835913



115 | Oregon Oak

TORE 60 | 5905167835517
TORE 80 | 5905167835906



109 | Georgia Oak

TORE 60 | 5905167835456
TORE 80 | 5905167835845



151 | Baker Concrete

TORE 60 | 5905167835678
TORE 80 | 5905167836064



152 | Hamburg Concrete

TORE 60 | 5905167835685
TORE 80 | 5905167836071



101 | Glacier Concrete

TORE 60 | 5905167835654
TORE 80 | 5905167836040



103 | Tokio Concrete

TORE 60 | 5905167835661
TORE 80 | 5905167836057



104 | Toronto Concrete

TORE 60 | 5905167835555
TORE 80 | 5905167835944

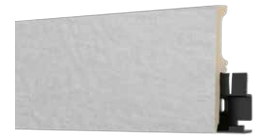

105 | Miami Concrete

TORE 60 | 5905167835562
TORE 80 | 5905167835951



101 | Brooklyn Concrete

TORE 60 | 5905167835579
TORE 80 | 5905167835968



103 | Broadway Concrete

TORE 60 | 5905167835586
TORE 80 | 5905167835975



104 | Manhattan Concrete

TORE 60 | 5905167835593
TORE 80 | 5905167835982



105 | Soho Concrete

TORE 60 | 5905167835548
TORE 80 | 5905167835937



113 | Panama Oak

TORE 60 | 5905167835494
TORE 80 | 5905167835883



108 | Dakota Oak

TORE 60 | 5905167835449
TORE 80 | 5905167835838



158 | Harlow Oak

TORE 60 | 5905167835746
TORE 80 | 5905167836132



106 | Portland Oak

TORE 60 | 5905167836941
TORE 80 | 5905167835814



107 | Pasadena Oak

TORE 60 | 5905167836934
TORE 80 | 5905167835821



169 | Weisshorn Oak

TORE 60 | 5905167843178
TORE 80 | 5905167843215



157 | Ridgefield Oak

TORE 60 | 5905167835739
TORE 80 | 5905167836125



167 | Preston Oak

TORE 60 | 5905167839430
TORE 80 | 5905167839447



146 | Wellington Oak

TORE 60 | 5905167835616
TORE 80 | 5905167836002



114 | Williamsburg Oak

TORE 60 | 5905167835500
TORE 80 | 5905167835890



159 | Wembley Oak

TORE 60 | 5905167835753
TORE 80 | 5905167836149



156 | Leonard Oak

TORE 60 | 5905167835722
TORE 80 | 5905167836118



155 | Mayne Oak

TORE 60 | 5905167835715
TORE 80 | 5905167836101



146 | Belford Oak

TORE 60 | 5905167835623
TORE 80 | 5905167836019



148 | Gaillarde Oak

TORE 60 | 5905167843161
TORE 80 | 5905167843208

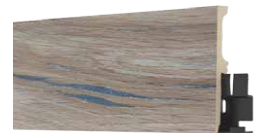

170 | Patendorf Oak

TORE 60 | 5905167843185
TORE 80 | 5905167843222



110 | Yakima Oak

TORE 60 | 5905167835463
TORE 80 | 5905167835852



111 | Nevada Walnut

TORE 60 | 5905167835470
TORE 80 | 5905167835869



153 | Yankee Oak

TORE 60 | 5905167835692
TORE 80 | 5905167836088



171 | Stamberger Oak

TORE 60 | 5905167843192
TORE 80 | 5905167843239



154 | Sierra Oak

TORE 60 | 5905167835708
TORE 80 | 5905167836095



147 | Georgetown Oak

TORE 60 | 5905167835630
TORE 80 | 5905167836026



148 | Grants Oak

TORE 60 | 5905167835647
TORE 80 | 5905167836033



NEW

176 | Hayworth Oak

TORE 60 | 5905167845806
TORE 80 | 5905167845851



NEW

177 | Medici Oak

TORE 60 | 5905167845813
TORE 80 | 5905167845868



NEW

181 | Stamford Oak

TORE 60 | 5905167845820
TORE 80 | 5905167845875



NEW

187 | Dearwood Oak

TORE 60 | 5905167845837
TORE 80 | 5905167845882



NEW

184 | Windsor Oak

TORE 60 | 5905167845844
TORE 80 | 5905167845899



VIGO 80



- HYBRID TECHNOLOGY
- NO NEED FOR SILICONE
- FLEXIBLE AND DURABLE
- PROTECTIVE LAYER
- WATERPROOF AND DIRT RESISTANCE
- QUICK INSTALLATION
- GLUING CHANNEL

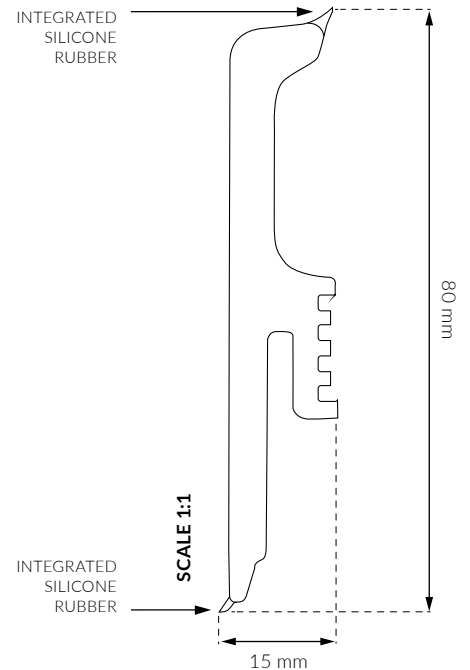

SKIRTING



STRONGMAN GLUE



CLIPS AND DOWELS



CLIP



DOWEL



ACCESSORIES



ACCESSORIES



EAN

220 cm

-

ø 6 mm

-

1 pc

20 pcs

2 pcs

2 pcs

2 pcs

1L + 1R

22 m

12 pcs

1200 pcs

30 pcs

30 pcs

30 pcs

30 pcs

5905167788264

5905167826737



01 | White | RAL 9003
SKIRTING | 5905167826478
CS PROFILE | 40



03 | Dark Gray | RAL 7042
SKIRTING | 5905167826492
CS PROFILE | A1



PROTECTIVE FOIL
Protective foil removable
after renovation

PERFECT CORNERS



CUTTING METHODS OF CORNERS



MANUAL CUTTING
The possibility of cutting
corners with a hand saw



MITRE SAW
The possibility of cutting
corners with a mitre saw



VIGO 60

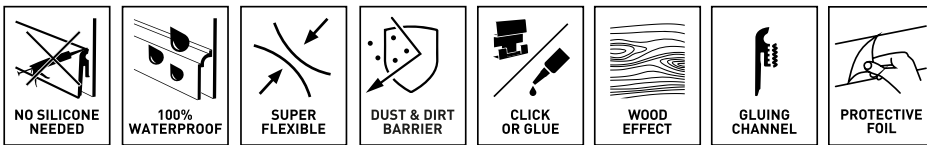

- HYBRID TECHNOLOGY
- NO NEED FOR SILICONE
- FLEXIBLE AND DURABLE
- PROTECTIVE LAYER
- WATERPROOF AND DIRT RESISTANCE
- QUICK INSTALLATION
- GLUING CHANNEL

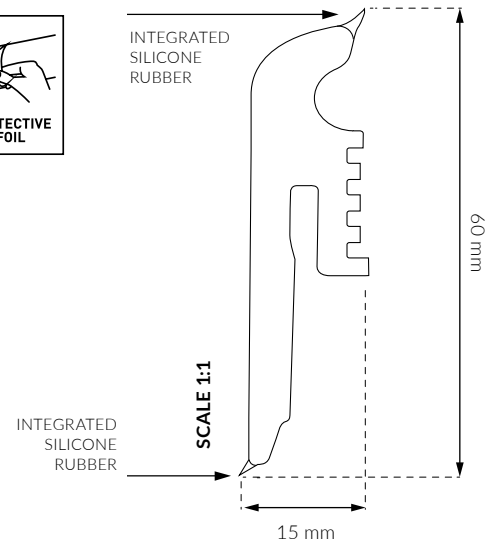

	220 cm	-	ø 6 mm				
	-	1 pc	20 pcs	2 pcs	2 pcs	2 pcs	1L + 1R
	22 m	12 pcs	1200 pcs	30 pcs	30 pcs	30 pcs	30 pcs

EAN 5905167788264 5905167826737



01 | White | RAL 9003
SKIRTING | 5905167825679
CS PROFILE | 40



02 | Gray | RAL 7035
SKIRTING | 5905167825686
CS PROFILE | A1



03 | Dark Gray | RAL 7042
SKIRTING | 5905167825693
CS PROFILE | 45



04 | Anthracite | RAL 7024
SKIRTING | 5905167825709
CS PROFILE | 52



102 | Scandinavian Oak
SKIRTING | 5905167825716
CS PROFILE | 19



112 | Bradford Oak
SKIRTING | 5905167825723
CS PROFILE | 27



107 | Vermont Oak
SKIRTING | 5905167825747
CS PROFILE | 03



158 | Monument Oak
SKIRTING | 5905167825730
CS PROFILE | 158



159 | Newport Oak
SKIRTING | 5905167825754
CS PROFILE | 159



160 | Calvia Oak
SKIRTING | 5905167825761
CS PROFILE | 159



161 | Goldberg Oak
SKIRTING | 5905167825778
CS PROFILE | 159



163 | Rosspot Oak
SKIRTING | 5905167825792
CS PROFILE | 09



154 | Sierra Oak
SKIRTING | 5905167825822
CS PROFILE | 47



110 | Jersey Oak
SKIRTING | 5905167825808
CS PROFILE | 07



147 | Georgetown Oak
SKIRTING | 5905167825815



162 | Cornwall Oak
SKIRTING | 5905167825785
CS PROFILE | 162



25 | Girona Chestnut
SKIRTING | 5905167844960
CS PROFILE | 25



44 | Bolton Oak
SKIRTING | 5905167844977
CS PROFILE | 42, 19



16 | Caucasian Oak
SKIRTING | 5905167844984
CS PROFILE | 23



22 | Northern Ash
SKIRTING | 5905167844991
CS PROFILE | 02



173 | Rodenbach Oak
SKIRTING | 5905167845004
CS PROFILE | 158



09 | Manorial Oak
SKIRTING | 5905167845011
CS PROFILE | 47



12 | Dark Oak
SKIRTING | 5905167845028
CS PROFILE | 12



174 | Porto Oak
SKIRTING | 5905167845035
CS PROFILE | 11

PERFECT CORNERS



CUTTING METHODS OF CORNERS



MANUAL CUTTING

The possibility of cutting corners with a hand saw



MITRE SAW

The possibility of cutting corners with a mitre saw

SKIRTING BOARDS

NON-PVC WATERPROOF COLLECTIONS

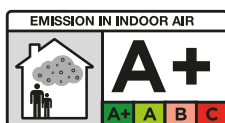

Information sur le niveau d'émission de substances volatiles dans l'air intérieur, présentant un risque de toxicité par inhalation, sur une échelle de classe allant de A+ (très faibles émissions) à C (fortes émissions)

 0%
PHTHALATES



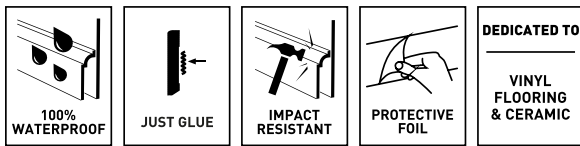

STIQ
AVIA
VEGA
INTEGRA

NON-PVC
WATERPROOF



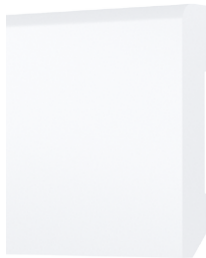
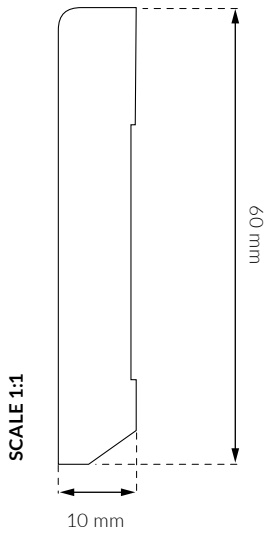

- WATERPROOF
- JUST GLUE
- IMPACT RESISTANT
- HOMOGENEOUS MATERIAL (100% PVC FREE)
- NO PAINTS AND LACQUERS
- VOC FREE
- PERFECT FOR RECYCLING
- DEDICATED TO VINYL FLOORING & CERAMIC

	SKIRTING	STRONGMAN GLUE	ACRYLIC
 220 cm	-	-	
 -	1 pc	1 pc	
 44 m	12 pcs	12 pcs	
EAN	5905167788264	5907584890193	

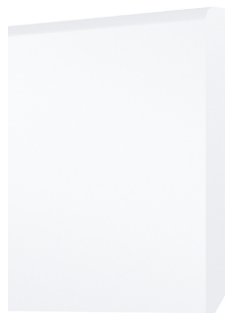
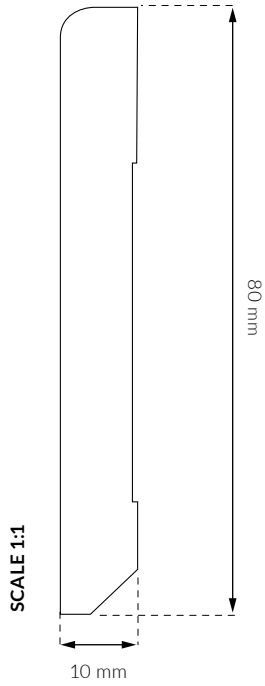

White
 S611 | 5905167839997
 | 44 m



White
 S810 | 5905167839850
 | 44 m

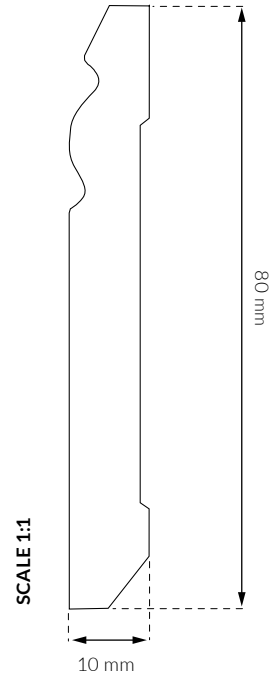

White
 S820 | 5905167839867
 | 44 m





PROTECTIVE FOIL
 Protective foil removable
 after renovation

STIQ XL

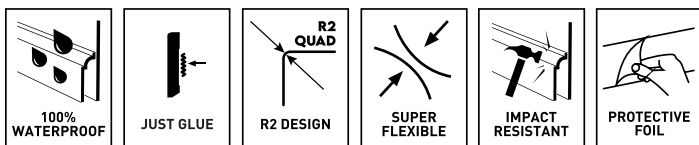
NEW



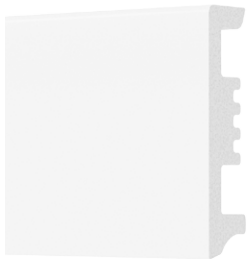
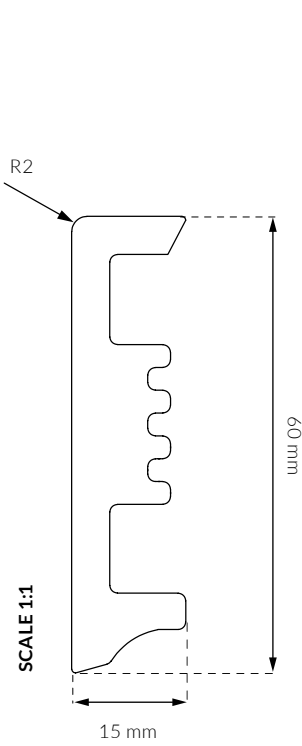

- WATERPROOF
- R2 DESIGN
- JUST GLUE
- SUPER FLEXIBLE
- IMPACT RESISTANT
- HOMOGENEOUS MATERIAL (100% PVC FREE)
- NO PAINTS AND LACQUERS
- VOC FREE
- PERFECT FOR RECYCLING

	SKIRTING	STRONGMAN GLUE	ACRYLIC
	220 cm	-	-
	-	1 pc	1 pc
	44 m	12 pcs	12 pcs
EAN		5905167788264	5907584890193

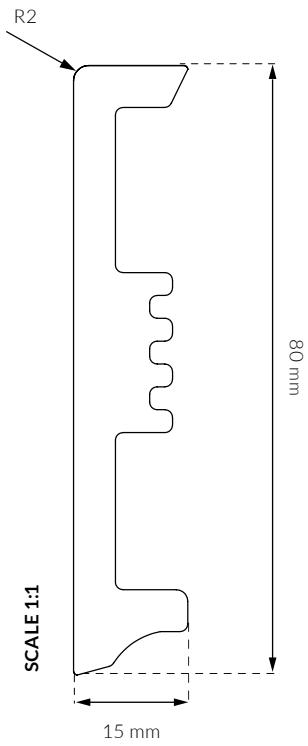

White
 STX610 | 5905167839874
 | 44 m



White
 STX810 | 5905167839881
 | 44 m

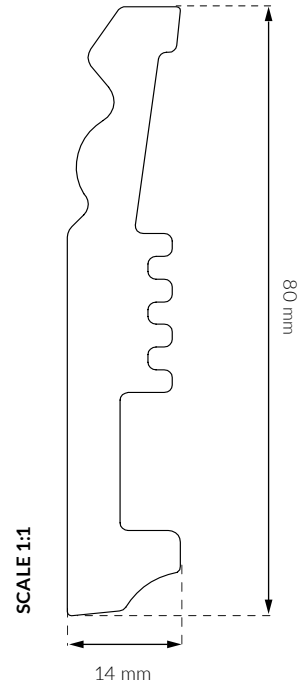

White
 STX820 | 5905167839898
 | 44 m



PROTECTIVE FOIL
 Protective foil removable
 after renovation

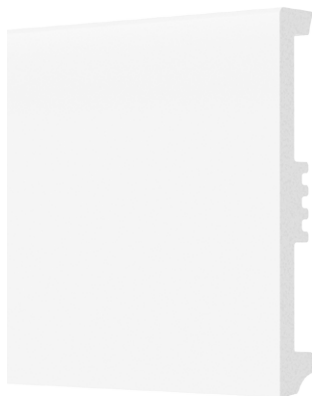
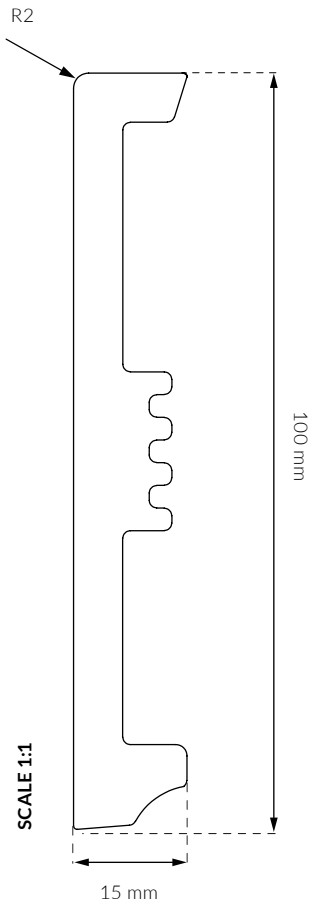

White
 STX110 | 5905167839904
 44 m

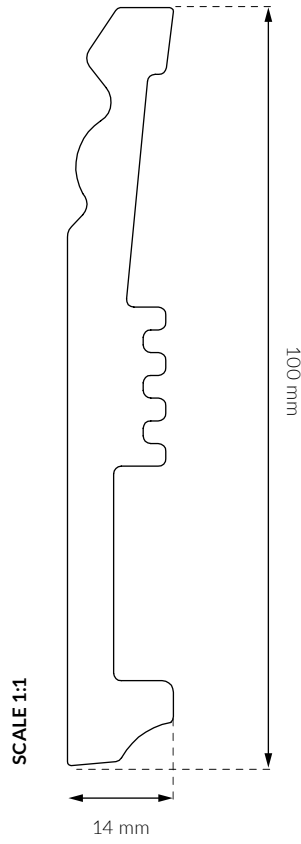

White
 STX120 | 5905167839911
 44 m





PROTECTIVE FOIL

Protective foil
 removable
 after renovation

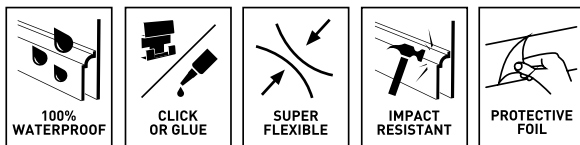



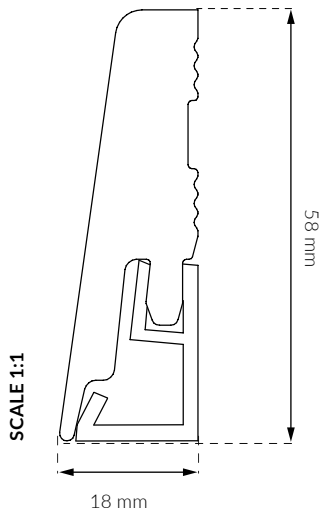

- WATERPROOF
- PERFECT FOR RENOVATION
- JUST GLUE
- SUPER FLEXIBLE
- IMPACT RESISTANT
- HOMOGENEOUS MATERIAL (100% PVC FREE)
- NO PAINTS AND LACQUERS
- VOC FREE
- PERFECT FOR RECYCLING

	SKIRTING	STRONGMAN GLUE	ACRYLIC	ACCESSORIES			
 220 cm	-	-	-	-	-	-	-
 -	1 pc	1 pc	2 pcs / 15 pack	2 pcs / 15 pack	2 pcs / 15 pack	1L + 1R 15 L 15 R	
 44 m	12 pcs	12 pcs	-	-	-	-	-
EAN	5905167788264	5907584890193					

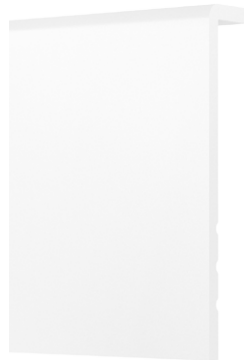
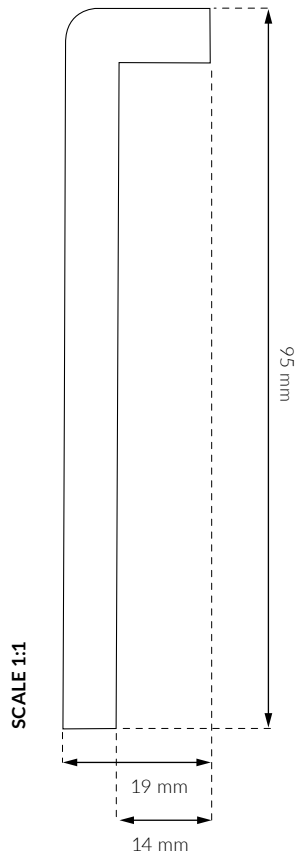

White
 STP580 | 5905167839928
 44 m



White
 STP950 | 5905167839980
 44 m



PROTECTIVE FOIL
 Protective foil
 removable
 after renovation



ACCESSORIES



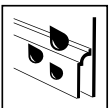
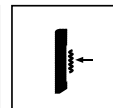
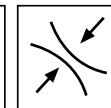
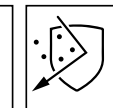

 100% WATERPROOF	 JUST GLUE	 SUPER FLEXIBLE	 DUST & DIRT BARRIER	PERFECT FOR ECOMMERCE	DEDICATED TO VINYL FLOORING & LAMINATE
---	---	--	---	------------------------------	---

- PERFECT FOR ECOMMERCE
- WATERPROOF
- JUST GLUE
- DUST AND DIRT BARRIER
- SUPER FLEXIBLE
- HOMOGENEOUS MATERIAL (100% PVC FREE)
- NO PAINTS AND LACQUERS
- VOC FREE
- PERFECT FOR RECYCLING

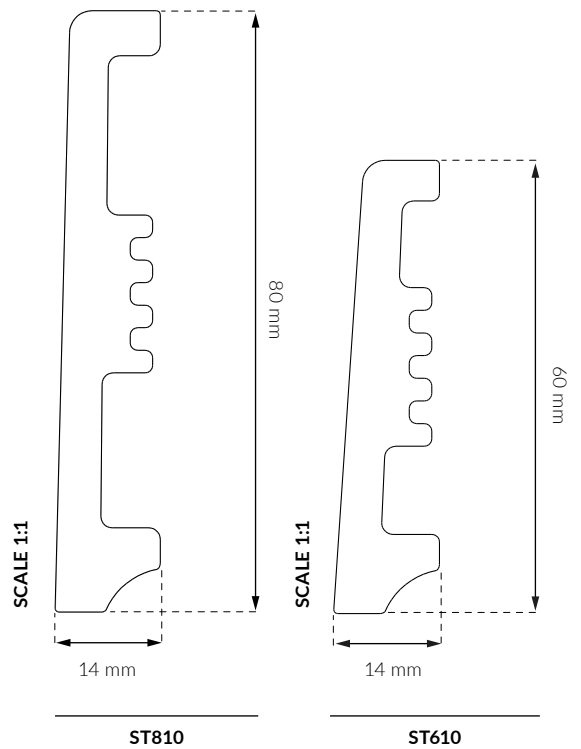





SKIRTING



STRONGMAN GLUE



ACRYLIC

 cm		200cm	-	-
		-	1 pc	1 pc
		20 m	12 pcs	12 pcs
EAN		5905167788264	5907584890193	



01 | White

ST610

5905167838877



01 | White

ST810







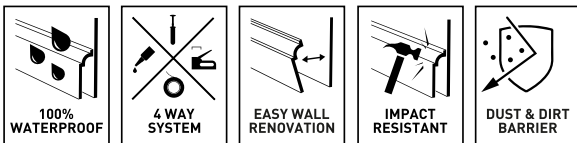

5905167838891





VEGA



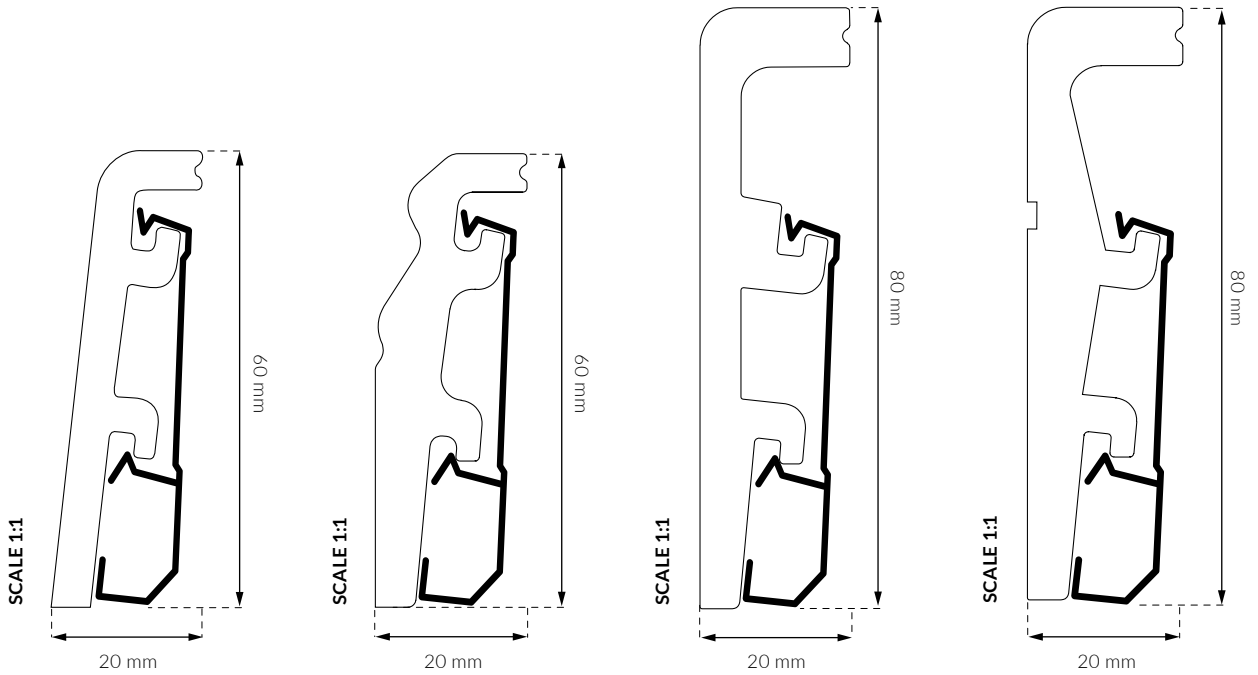

- WATERPROOF
- 4 WAY SYSTEM
- EASY WALL RENOVATION
- IMPACT RESISTANT
- DUST AND DIRT BARRIER
- 100% PVC FREE

					
	SKIRTING	BLOCKS	STRONGMAN GLUE	TAPE	ACRYLIC
	240 cm	2,3x2,3x15,2 cm	-	-	-
	-	4 pcs = 1 set	1 pc	1 pc	1 pc
	24 m / 28,8 m	10 sets	12 pcs	24 pcs	12 pcs
EAN		5905167746844	5905167788264	5905167731444	5907584890193

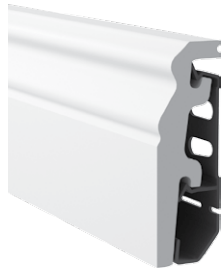

White
 P0610 | 5905167747926
 24 m



White
 P0620 | 5905167755662
 21,8 m



White
 P0810 | 5905167734551
 24 m



White
 P0811 | 5905167734568
 24 m

ACCESSORIES / UNIVERSAL BLOCK

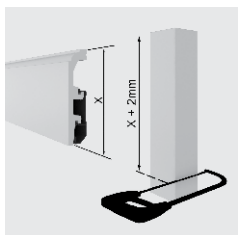
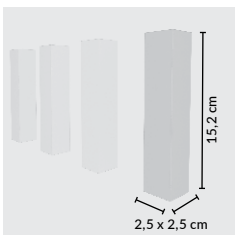

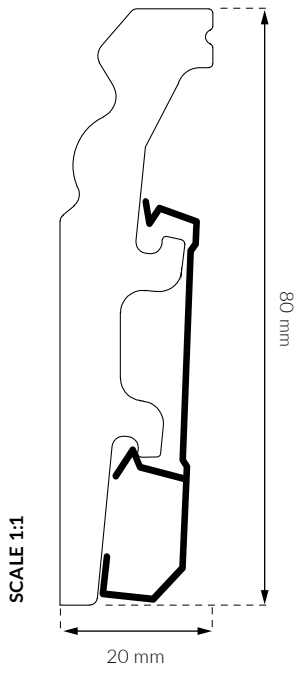

White

P0830 | 5905167755679
 24 m

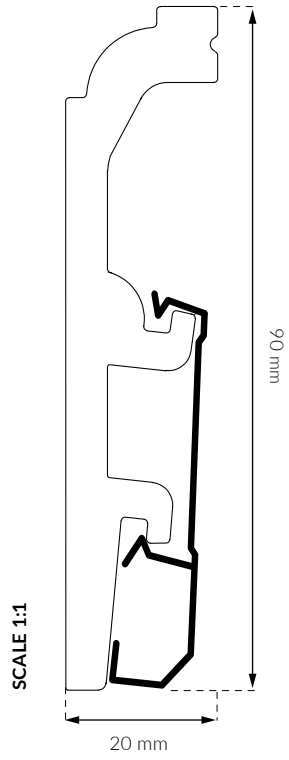

White

P0910 | 5905167734605
 24 m

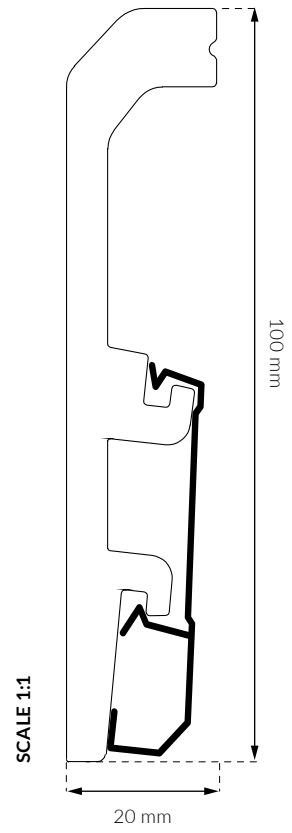

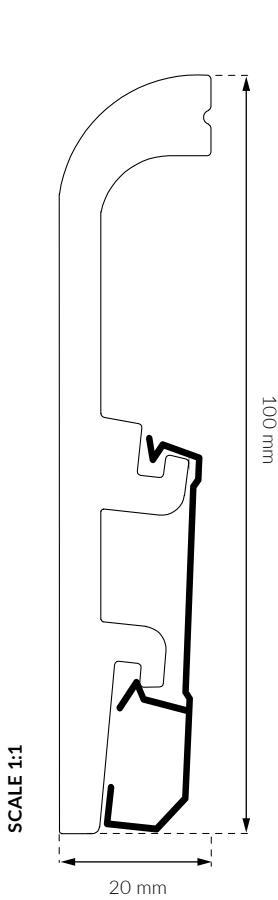

White

P1010 | 5905167734629
 24 m

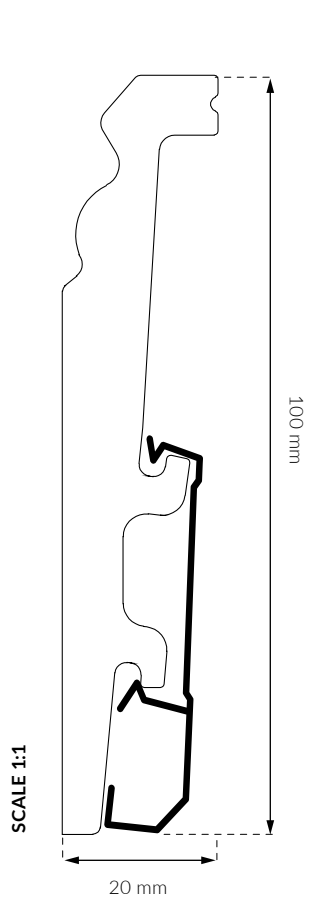

White
 P1020 | 5905167734643
 24 m



White
 P0910 | 5905167734605
 24 m

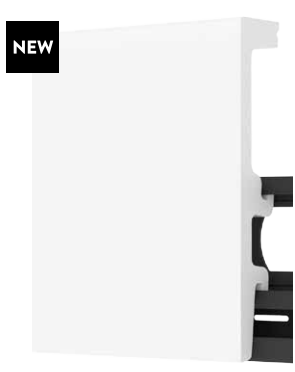
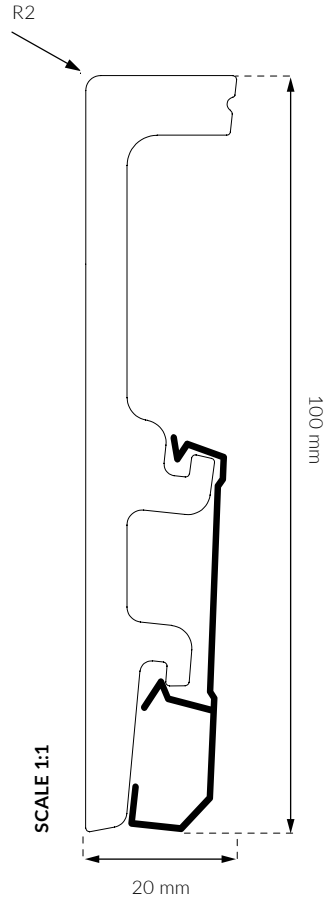

White
 P1040 | 5905167839843
 24 m

INTEGRA

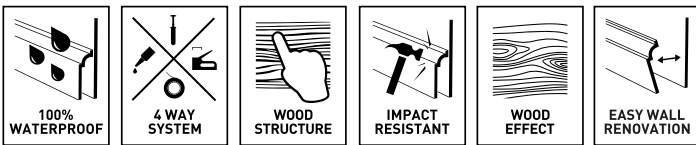

- WATERPROOF
- 4 WAY SYSTEM
- IMPACT RESISTANT
- WOOD STRUCTURE
- IMPACT RESISTANT
- WOOD EFFECT
- EASY WALL RENOVATION
- HOMOGENEOUS MATERIAL (100% PVC FREE)
- NO PAINTS AND LACQUERS
- VOC FREE
- PERFECT FOR RECYCLING

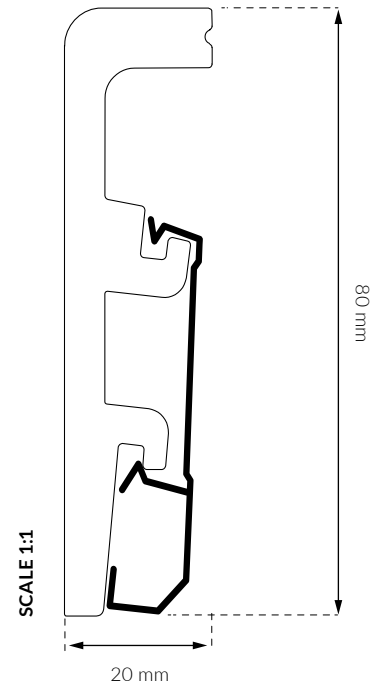

SKIRTING



STRONGMAN GLUE



TAPE



240 cm

-

-



-

1 pc

1 pcs



24 m

12 pcs

24 pcs

EAN

5905167788264

5905167731444



01 | White
SKIRTING | 5905167734353



02 | Aluminium
SKIRTING | 5905167734360



3 | Snow Ash
SKIRTING | 5905167734377



12 | Roma Oak
SKIRTING | 5905167734469



7 | Alabama Oak
SKIRTING | 5905167734414



14 | Oregon Oak
SKIRTING | 5905167734483



5 | City Oak
SKIRTING | 5905167734391



4 | Northern Ash
SKIRTING | 5905167734384



6 | Alaska Ash
SKIRTING | 5905167734407



11 | Persian Oak
SKIRTING | 5905167734452



46 | Davos Oak
SKIRTING | 5905167838228



44 | Manorial Oak
SKIRTING | 5905167838204



9 | Classic Oak
SKIRTING | 5905167734438



8 | Nevada Oak
SKIRTING | 5905167734421



10 | Calvados Oak
SKIRTING | 5905167734445



19 | Natural Oak
SKIRTING | 5905167734537



18 | Loft Oak
SKIRTING | 5905167734520



17 | Dark Walnut
SKIRTING | 5905167734513



45 | Wenge Africa
SKIRTING | 5905167838211



20 | Borneo Oak
SKIRTING | 5905167734544

SKIRTING BOARDS

MODERN PVC
COLLECTIONS





INDO
LARS
MACK

MODERN
PVC



WOOD STRUCTURE

4 WAY SYSTEM

WOOD EFFECT

FLEXIBLE

EASY WALL RENOVATION

EMISSION IN INDOOR AIR
A+
A+ A B C

Information sur le niveau d'émission de substances volatiles dans les intérieurs, présentant un risque de toxicité par inhalation, voir une échelle de classe allant de A+ (très faibles émissions) à C (fortes émissions)

- WOOD STRUCTURE
- 4 WAY SYSTEM
- WOOD EFFECT
- FLEXIBLE
- EASY WALL RENOVATION
- ECO FRIENDLY

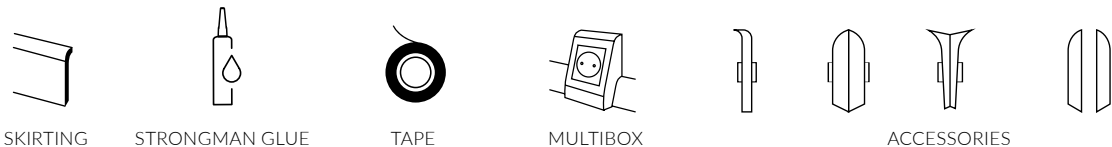
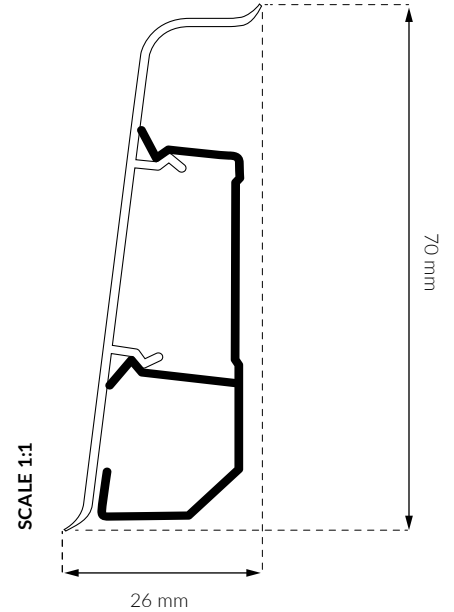

	250 cm	-	-	-	-	-	-	-
	-	1 pc	1 pc	1 pc	2 pcs / 20 pack	2 pcs / 20 pack	2 pcs / 20 pack	1L + 1R 20 L 20 R
	25 m	12 pcs	24 pcs	10 pcs	30 pcs / 1440 pack	30 pcs / 360 pack	30 pcs / 360 pack	30 pcs / 720 pack 30 pcs / 720 pack

EAN 5905167788264 5905167731444 5906735698503



01 | White

SKIRTING | 5905167725719
CS PROFILE | 40

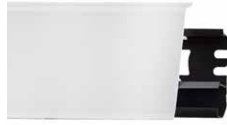

40 | White Mat

SKIRTING | 5905167781685
CS PROFILE | 40



134 | Cambridge

SKIRTING | 5905167806036



133 | Oxford

SKIRTING | 5905167806029
CS PROFILE | 45



41 | Alu Light

SKIRTING | 5905167781340
CS PROFILE | A1



17 | Aluminium

SKIRTING | 5905167729281



25 | Girona Chestnut

SKIRTING | 5905167781326
CS PROFILE | 19



19 | Ontario Oak

SKIRTING | 5905167755006



44 | Bolton Oak

SKIRTING | 5905167799000
CS PROFILE | 02



137 | Selma Oak

SKIRTING | 5905167816981
CS PROFILE | 50



135 | Platinum Oak

SKIRTING | 5905167806067



112 | Bradford Oak

SKIRTING | 5905167838235



16 | Caucasian Oak

SKIRTING | 5905167725863



23 | Modena Oak

SKIRTING | 5905167755044
CS PROFILE | 23



131 | Philadelphia Oak

SKIRTING | 5905167806043
CS PROFILE | 46



02 | Northern Ash

SKIRTING | 5905167725726
CS PROFILE | 26



42 | Sand Oak

SKIRTING | 5905167781692
CS PROFILE | 03



20 | Burgos Oak

SKIRTING | 5905167755013
CS PROFILE | 20



03 | Loft Oak

SKIRTING | 5905167725733
CS PROFILE | 03



138 | Pasadena Oak

SKIRTING | 5905167816998
CS PROFILE | 44



158 | Monument Oak

SKIRTING | 5905167838259
CS PROFILE | 158



04 | Lingburg Oak

SKIRTING | 5905167725740
CS PROFILE | 04



153 | Yankee Oak
SKIRTING | 5905167825075



05 | Windston Oak
SKIRTING | 5905167725757
CS PROFILE | 31



154 | Sierra Oak
SKIRTING | 5905167825082
CS PROFILE | 07



09 | Manorial Oak
SKIRTING | 5905167725795
CS PROFILE | 65



110 | Jersey Oak
SKIRTING | 5905167838242



10 | Bourbon Oak
SKIRTING | 5905167725801
CS PROFILE | 09



139 | Satin Oak
SKIRTING | 5905167817001



43 | Victoria Oak
SKIRTING | 5905167781333



12 | Dark Oak
SKIRTING | 5905167725825
CS PROFILE | 12



11 | Holm Oak
SKIRTING | 5905167725818
CS PROFILE | 11



140 | Tasmanian Oak
SKIRTING | 5905167817018
CS PROFILE | 49

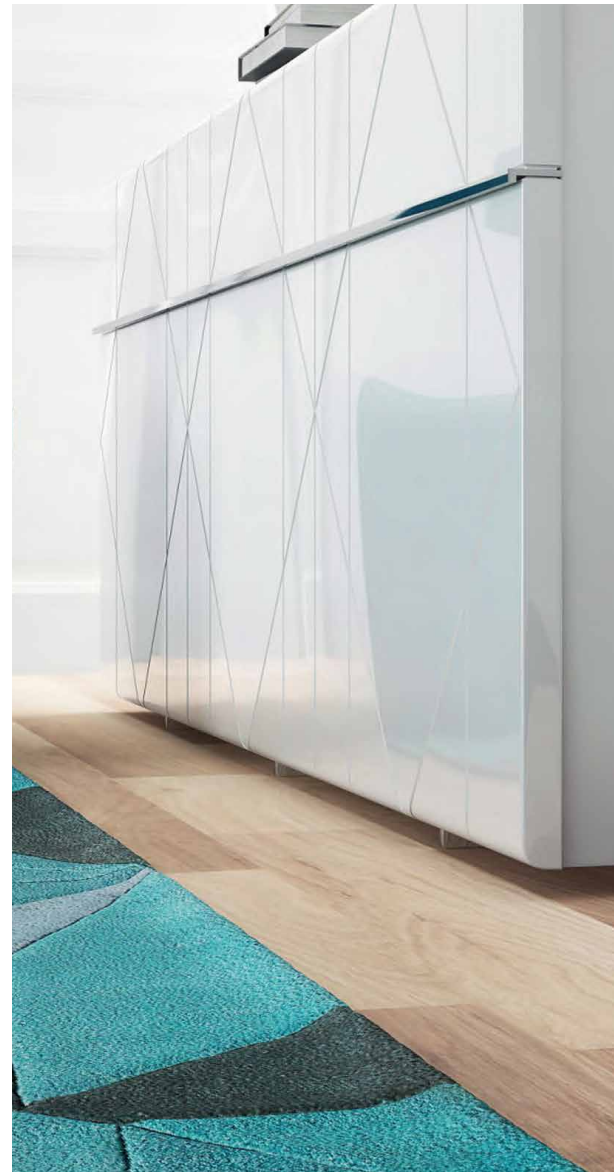

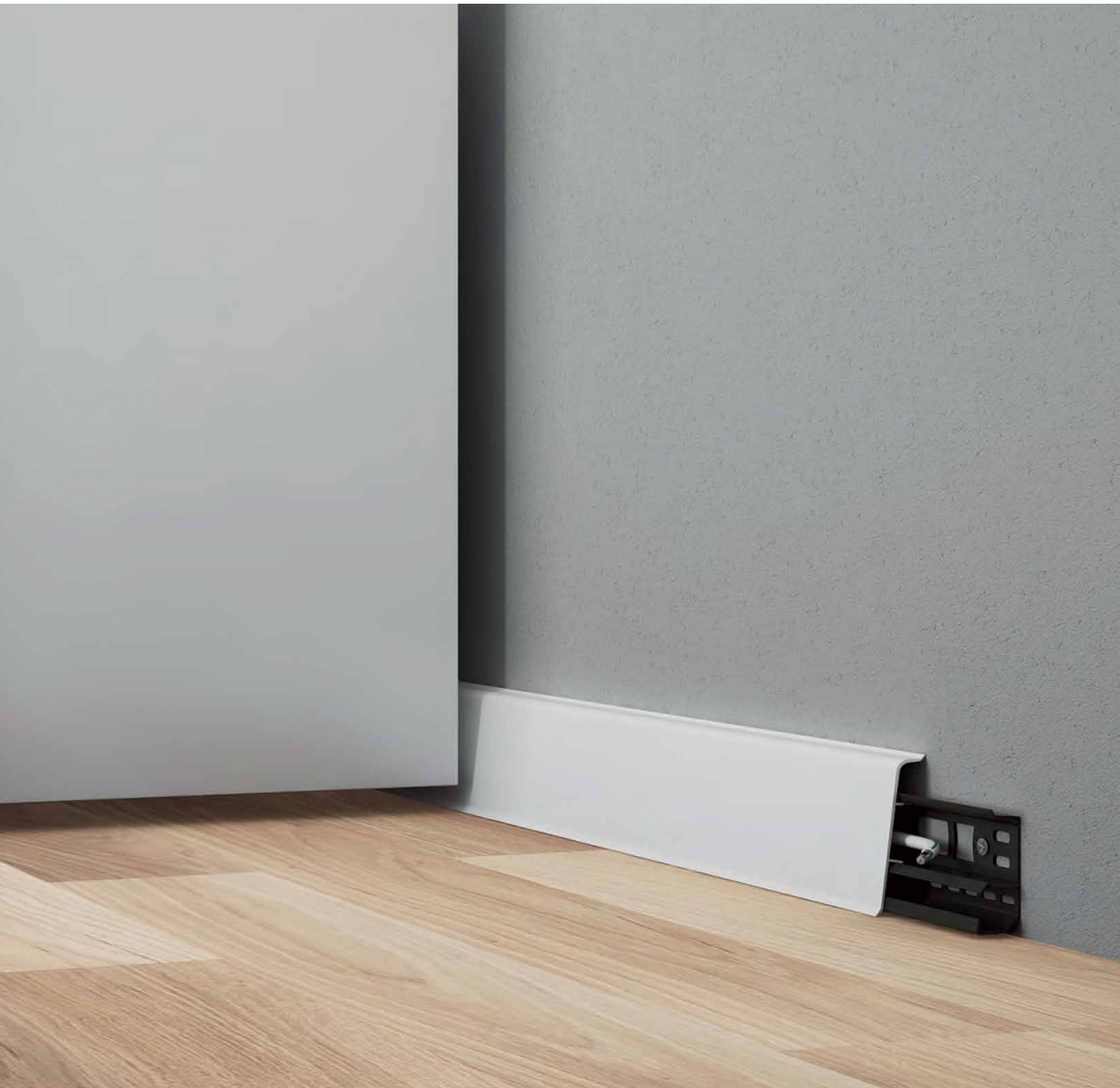

LARS





**WOOD
STRUCTURE**



**EASY
INSTALLATION**





FLEXIBLE

**MODERN
DESIGN**

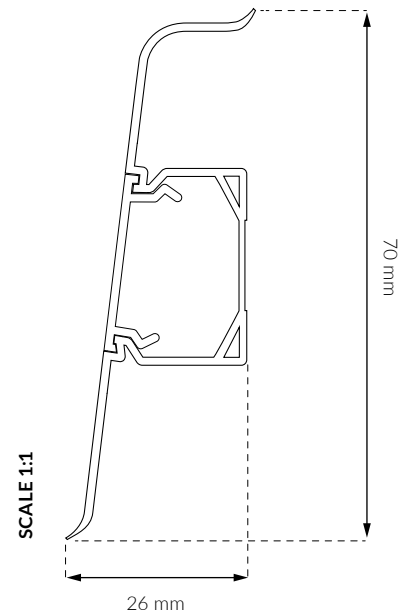
- WOOD STRUCTURE
- EASY INSTALLATION
- FLEXIBLE
- MODERN DESIGN
- ECO FRIENDLY

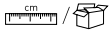

	SKIRTING	STRONGMAN GLUE	TAPE	MULTIBOX	ACCESSORIES			
 250 cm	-	-	-	-	-	-	-	-
 -	1 pc	1 pc	1 pc	2 pcs / 20 pack	2 pcs / 20 pack	2 pcs / 20 pack	1L + 1R 20 L 20 R	
 50 m	12 pcs	24 pcs	10 pcs	30 pcs / 1440 pack	30 pcs / 360 pack	30 pcs / 360 pack	30 pcs / 720 pack	30 pcs / 720 pack
EAN	5905167788264	5905167731444	5906735698503					



40 | White Mat

SKIRTING | 5905167783504
CS PROFILE | 40



41 | Alu Light

SKIRTING | 5905167817391



25 | Snow Ash

SKIRTING | 5905167783474
CS PROFILE | 29



02 | Winterwood Ash

SKIRTING | 5905167783399
CS PROFILE | 27



44 | Platinum Oak

SKIRTING | 5905167783535



50 | Scandinavian Oak

SKIRTING | 5905167783580
CS PROFILE | 48



137 | Selma Oak

SKIRTING | 5905167817384
CS PROFILE | 50



16 | Holm Oak

SKIRTING | 5905167783429



42 | Arena Oak

SKIRTING | 5905167783511
CS PROFILE | 03



03 | Norwegian Oak

SKIRTING | 5905167783412
CS PROFILE | 03



04 | Alpine Oak

SKIRTING | 5905167783443
CS PROFILE | 04



45 | Swedish Oak

SKIRTING | 905167783528



46 | Golden Oak

SKIRTING | 5905167783559
CS PROFILE | 09



09 | Noble Oak

SKIRTING | 5905167783436
CS PROFILE | 29



47 | Tatra Oak

SKIRTING | 5905167783542



32 | Elegant Oak

SKIRTING | 5905167783498
CS PROFILE | 39



12 | Brazilian Walnut

SKIRTING | 5905167783450
CS PROFILE | 12



14 | Wood Wenge

SKIRTING | 5905167783405

ACCESSORIES



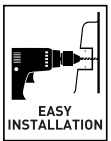

MODERN DESIGN

- MODERN DESIGN
- EASY INSTALLATION
- FLEXIBLE
- ECO FRIENDLY

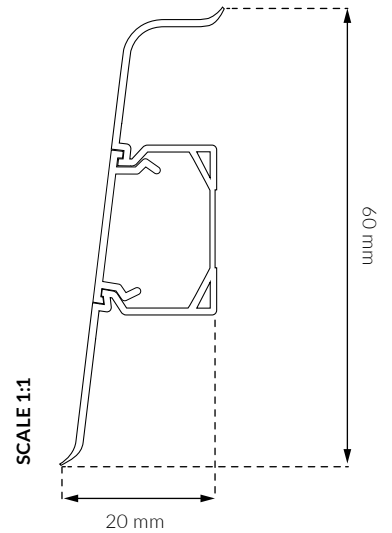

SKIRTING



STRONGMAN GLUE



TAPE



MULTIBOX



ACCESSORIES



EAN

250 cm	-	-	-	-	-	-	-	-
-	1 pc	1 pc	1 pc	2 pcs / 25 pack	2 pcs / 25 pack	2 pcs / 25 pack	1L + 1R 25 L 25 R	
50 m	12 pcs	24 pcs	10 pcs	30 pcs / 1440 pack	30 pcs / 360 pack	30 pcs / 360 pack	30 pcs / 720 pack	30 pcs / 720 pack

5905167788264

5905167731444

5906735698503



40 | White Mat

SKIRTING | 5905167803554
CS PROFILE | 40



41 | Alu Light

SKIRTING | 5905167803721



25 | Girona Chestnut

SKIRTING | 5905167803578
CS PROFILE | 42



107 | Bolton Oak

SKIRTING | 5905167803585
CS PROFILE | 19



131 | Philadelphia Oak

SKIRTING | 5905167803622
CS PROFILE | 19



135 | Platinum Oak

SKIRTING | 5905167803615



16 | Caucasian Oak

SKIRTING | 5905167803639



02 | North Ash

SKIRTING | 5905167803592
CS PROFILE | 26



42 | Arena Oak

SKIRTING | 5905167803646



138 | Pasadena Oak

SKIRTING | 5905167825280
CS PROFILE | 44



03 | Loft Oak

SKIRTING | 5905167803653
CS PROFILE | 03



04 | Lingburg Oak

SKIRTING | 5905167803660
CS PROFILE | 04



153 | Yankee Oak

SKIRTING | 5905167825297
CS PROFILE | 153



136 | Antique Oak

SKIRTING | 5905167803677



154 | Sierra Oak

SKIRTING | 5905167825303
CS PROFILE | 07



46 | Golden Oak

SKIRTING | 5905167825273
CS PROFILE | 09



86 | Laplant Oak

SKIRTING | 5905167803684



132 | Edmonton Oak

SKIRTING | 5905167803707

ACCESSORIES



SKIRTING BOARDS

**TRADITIONAL
PVC**
COLLECTIONS

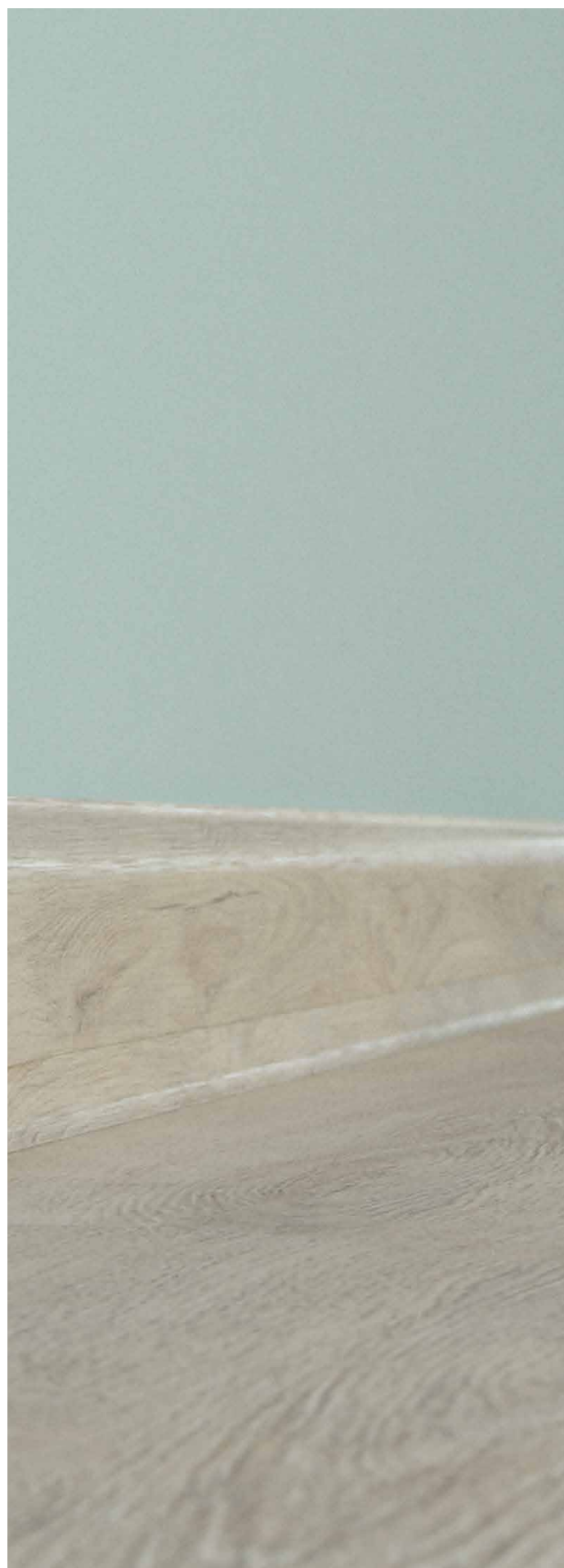



LM60
LM55

TRADITIONAL
PVC

LM60

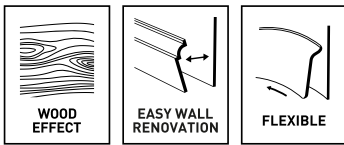

- FLEXIBLE ADAPTATION
- WOOD EFFECT
- ECO FRIENDLY PVC

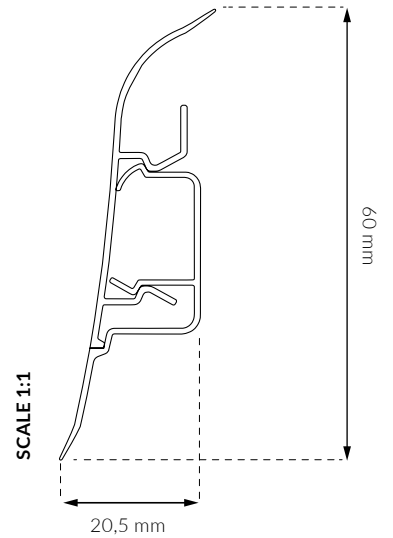

	SKIRTING	MULTIBOX	ACCESSORIES			
	250 cm	-	-	-	-	-
	-	1 pc	2 pcs / 25 pack	2 pcs / 25 pack	2 pcs / 25 pack	1L + 1R 25 L+25 R 25 L+25 R
	50 m	10 pcs	30 pcs / 1440 pack	30 pcs / 360 pack	30 pcs / 360 pack	30 pcs / 1440 pack 30 pcs / 1440 pack

EAN

5906735698503



34 | White
SKIRTING | 5905167749043



39 | Aluminium
SKIRTING | 5907749020014



107 | Bolton Oak
SKIRTING | 5905167752944



99 | Kendari Oak
SKIRTING | 5905167709542



44 | Golden Oak
SKIRTING | 5907749020083



58 | Country Oak
SKIRTING | 5905167662946



23 | Ash
SKIRTING | 5907749001891



109 | Sevilla Oak
SKIRTING | 5905167753149



77 | Sand Oak
SKIRTING | 5905167662953



65 | Canyon Oak
SKIRTING | 5905167662656



52 | Ardennes Oak
SKIRTING | 5907749020311



49 | Liverpool Oak
SKIRTING | 5907749020144



70 | White Oak
SKIRTING | 5905167663226



16 | Antique Oak
SKIRTING | 5906735694451



86 | Laplant Oak
SKIRTING | 5907749049282



72 | Bourbon Oak
SKIRTING | 5905167663264



63 | Tosca Oak
SKIRTING | 5905167663349



24 | Highland Oak
SKIRTING | 5907749012064



94 | Victoria Oak
SKIRTING | 5905167703175



74 | Rustic Oak
SKIRTING | 5905167663295



97 | Lagos Oak
SKIRTING | 5905167709528

ACCESSORIES

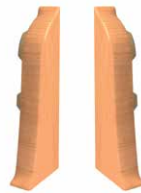

LM55

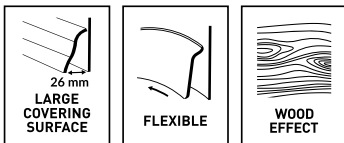

- WOOD EFFECT
- EASY WALL RENOVATION
- FLEXIBLE
- ECO FRIENDLY PVC

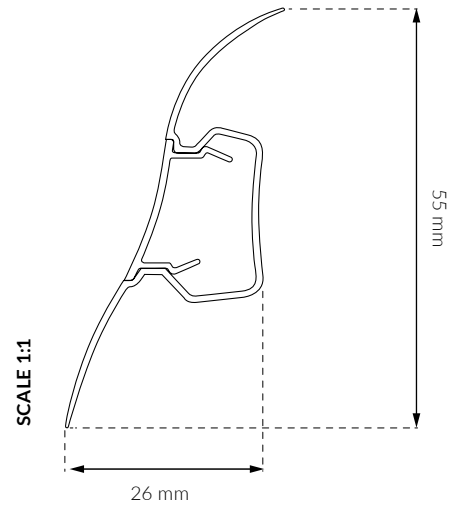

	250 cm	-	-	-	-	-	-
	-	1 pc	2 pcs / 25 pack	2 pcs / 25 pack	2 pcs / 25 pack	1L + 1R 25 L+25 R 25 L+25 R	
	50 m	10 pcs	30 pcs / 1440 pack	30 pcs / 360 pack	30 pcs / 360 pack	30 pcs / 1440 pack	30 pcs / 1440 pack

EAN 5906735698503



101 | White Matt
SKIRTING | 5905167735558



108 | Aspen Oak
SKIRTING | 5905167788349



107 | Girona Chestnut
SKIRTING | 5905167788332



45 | Grey Acacia
SKIRTING | 5907749020236



104 | Sardinia Oak
SKIRTING | 5905167741948



48 | Golden Oak
SKIRTING | 5907749020243



58 | Country Oak
SKIRTING | 5905167662748



103 | Havana Oak
SKIRTING | 5905167741153



77 | Sand Oak
SKIRTING | 5905167734810



49 | Belfast Oak
SKIRTING | 5907749020250



23 | Ash
SKIRTING | 5907749001174



102 | Almelo Oak
SKIRTING | 5905167741146



65 | Canyon Oak
SKIRTING | 5905167662762



110 | Ginkgo Biloba
SKIRTING | 5905167788363



47 | Liverpool Oak
SKIRTING | 5907749014853



109 | Ageing Oak
SKIRTING | 5905167788356



20 | Savoyen Oak
SKIRTING | 5906735647785



28 | Pecan
SKIRTING | 5907749001228



34 | Alaska Oak
SKIRTING | 5907749014716



16 | Antique Oak
SKIRTING | 5906735647747



85 | North Oak
SKIRTING | 5907749049329



67 | Classic Light Oak
SKIRTING | 5905167662885



86 | Laplant Oak
SKIRTING | 5905167670293



83 | Romantic Oak
SKIRTING | 5905167662915



26 | Dark Oak
SKIRTING | 5907749001204



112 | Jupiter Walnut
SKIRTING | 5905167788387



22 | Wenge Africa
SKIRTING | 5907749001167

ACCESSORIES

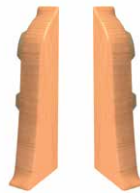

SKIRTING BOARDS

**TRADITIONAL
MDF**
COLLECTIONS

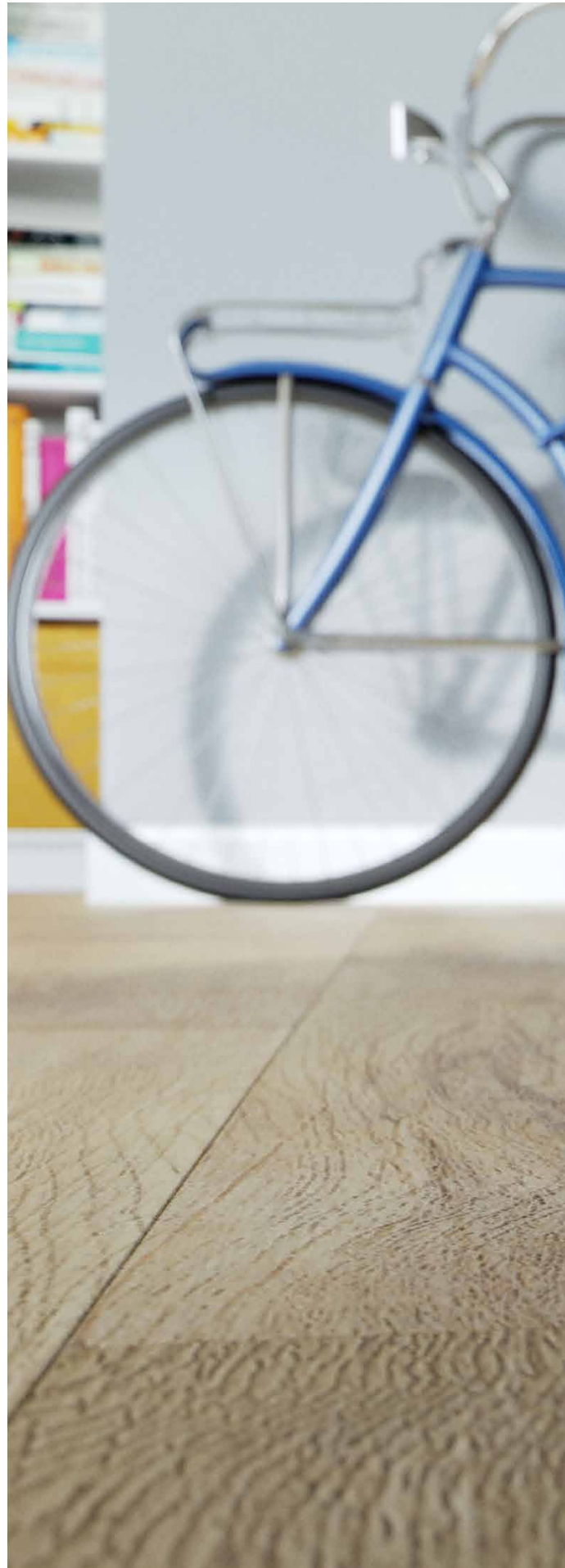









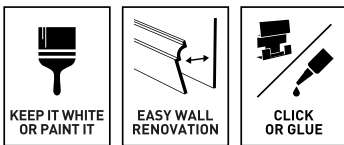

**PAINT IT
DIAMOND**

TRADITIONAL
MDF

PAINT IT



- KEEP IT WHITE OR PAINT IT
- EASY WALL RENOVATION
- CLICK OR GLUE

					
	SKIRTING	BLOCKS	CLIPS AND DOWELS	STRONGMAN GLUE	ACRYLIC
	242 cm	1,8x1,8x11,2 cm	ø 6 mm	-	-
	-	4 pcs = 1 set	25 pcs	1 pc	1 pc
	24,2 m	10 sets	1500 pcs	12 pcs	12 pcs
EAN		5905167736937	5905167674437	5905167788264	5907584890193

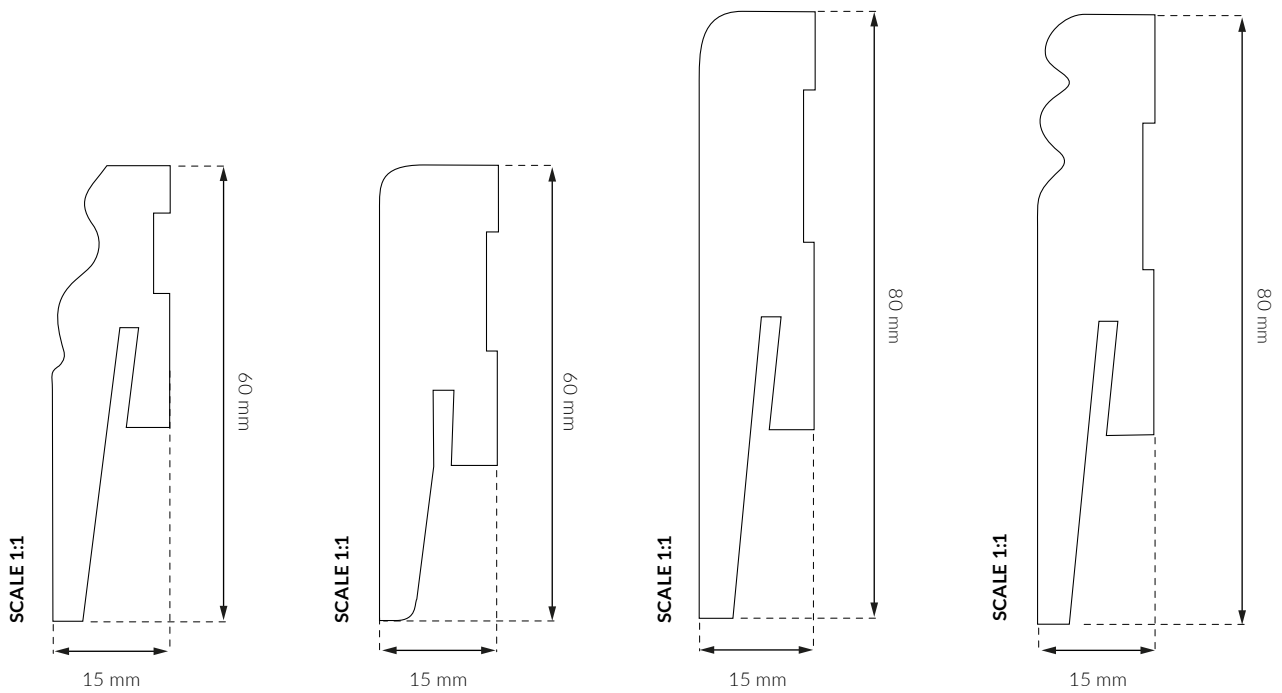

White
MP0601 | 5905167674338
24,2 m



White
MP0602 | 5905167754986
24,2 m



White
MP0801 | 5905167674345
24,2 m



White
MP0802 | 5905167674352
24,2 m

ACCESSORIES / UNIVERSAL BLOCK



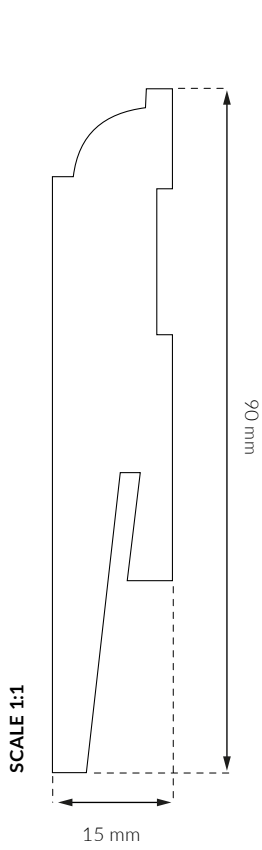

White

MP0901 | 5905167674369
 24,2 m

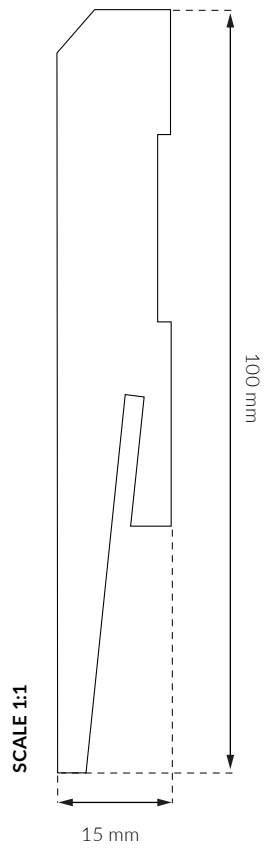

White

MP1001 | 5905167674376
 24,2 m

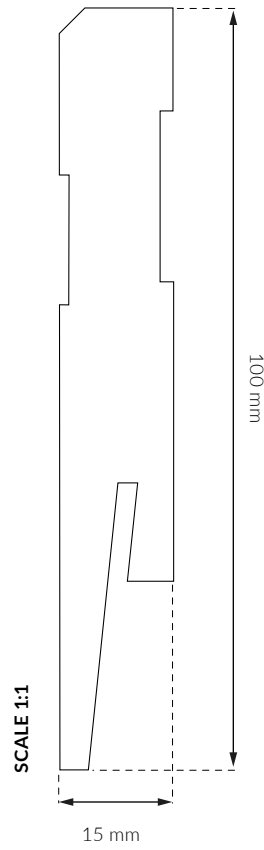

White

MP1002 | 5905167674383
 24,2 m

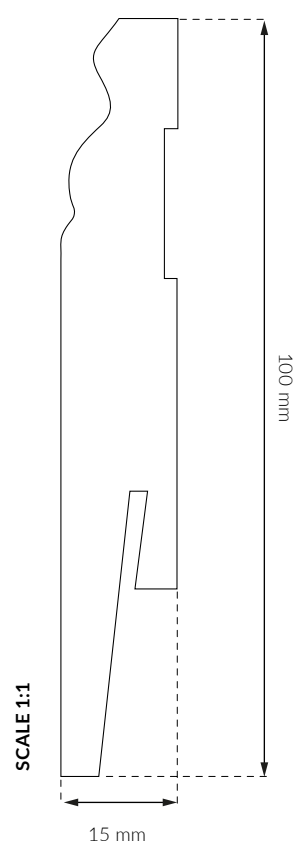

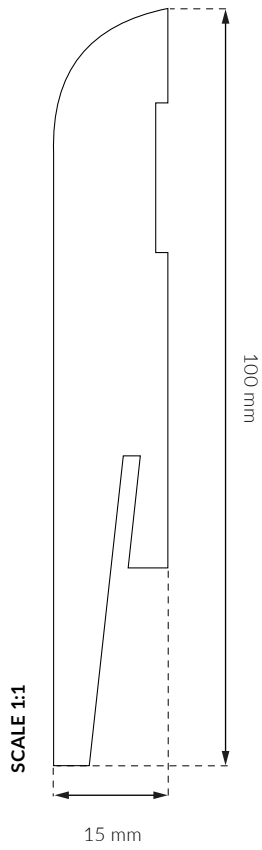

White

MP1003 | 5905167674390
 24,2 m

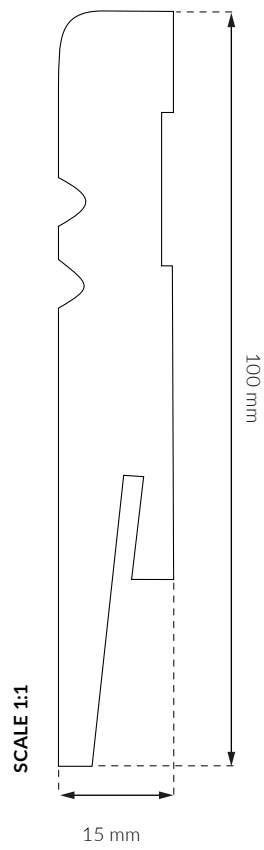

White
 MP1004 | 5905167674406
 24,2 m



White
 MP1005 | 5905167674413
 24,2 m

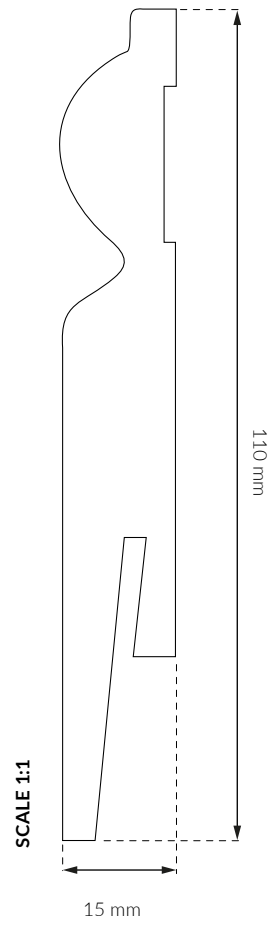

White
 MP1101 | 5905167674420
 24,2 m







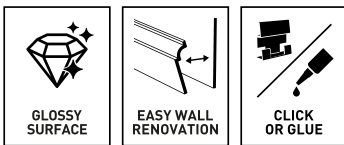

DIAMOND





MDF
NATURAL MATERIALS



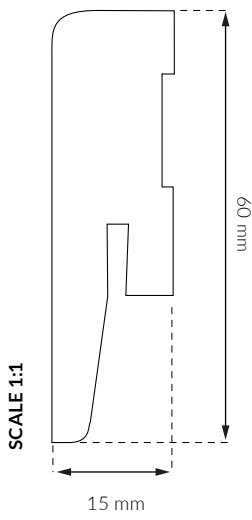

- GLOSSY SURFACE
- EASY WALL RENOVATION
- CLICK OR GLUE

					
	SKIRTING	BLOCKS	CLIPS AND DOWELS	STRONGMAN GLUE	ACRYLIC
	242 cm	1,8x1,8x11,2 cm	ø 6 mm	-	-
	-	4 pcs = 1 set	25 pcs	1 pc	1 pc
	24,2 m	10 sets	1500 pcs	12 pcs	12 pcs
EAN		5905167736937	5905167674437	5905167788264	5907584890193

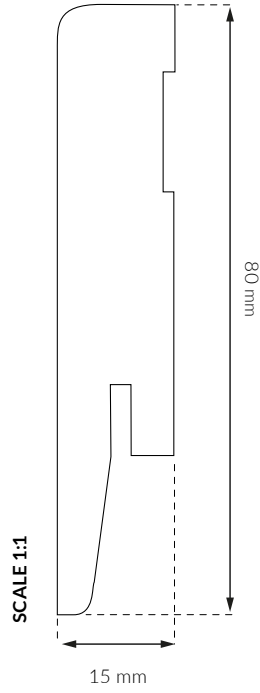

White
 GP0601 | 5905167766668
 21,8 m



White
 GP0801 | 5905167766675
 24 m

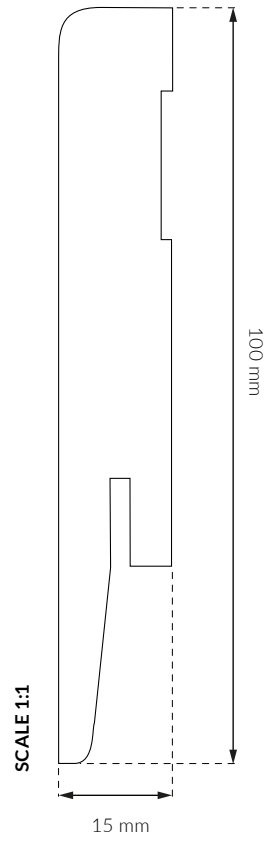

White
 GP1001 | 5905167766682
 24 m

ACCESSORIES / UNIVERSAL BLOCK

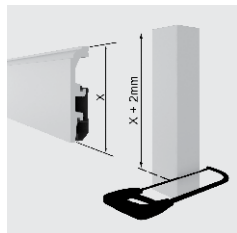
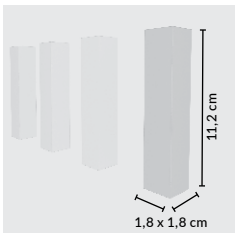

UNIVERSAL PROFILE



00 | Black 01 | White 03 | Beech 04 | White beech 07 | Dark oak 08 | White Oak 11 | Grey Ash 12 | Mahogany

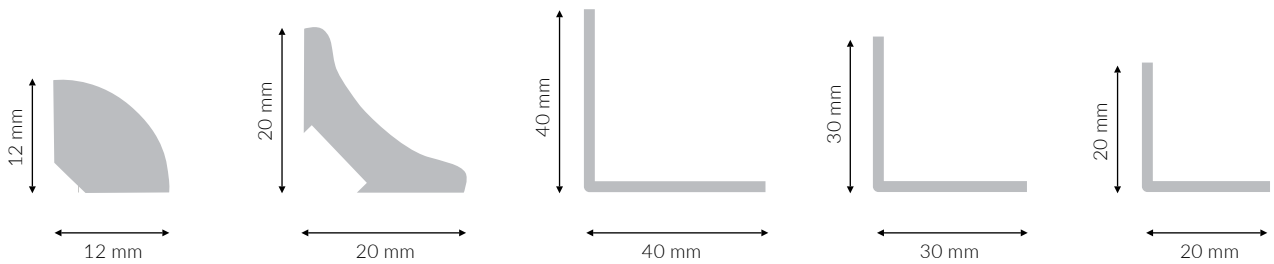

LC

QUARTER ROUND PROFILE

00		5907584871017
01		5907584871024
02		5907584871055
04		5907584871048
08		5907584871062
11		5907584871031

LN



CORNER PROFILE



00		5907584871109
01		5907584871116
02		5907584871147
04		5907584871130
08		5907584871154
11		5907584871123



LK



ANGLE BARS WITH BOTH SIDES PRINTED



00		5907584871208	00		5907584871307	00		5907584871406
01		5907584871215	01		5907584871314	01		5907584871413
02		5907584871246	02		5907584871345	02		5907584871444
07		5907584871222	07		5907584871321	07		5907584871420
08		5907584871239	08		5907584871338	08		5907584871437
11		5907584871253	11		5907584871352	11		5907584871451
12		5906735622478	12		5906735622485	12		5906735622492

		2,5 m
		50 m

		2,5 m
		50 m

		2,75 m
		55 m





		2,75 m
		55 m

		2,75 m
		55 m

ACCESSORIES







CLIPS AND DOWEL FOR TORE, VIGO, MDF COLLECTION

 / 		ø 6 mm
		20 pcs
		1200 pcs
EAN		5905167826737







TAPE

 / 		-
		1 pc
		24 pcs
EAN		5905167731444







STRONGMAN GLUE

 / 		-
		1 pc / 300 ml
		12 pcs
EAN		5905167788264







ACRYL





 / 		-
		1 pc / 300 ml
		12 pcs
EAN		5907584890193



BLOCKS FOR VEGA

 / 		2,3x2,3x15,2 cm
		4 pcs = 1 set
		10 sets
EAN		5905167746844

BLOCKS FOR MDF

 / 		1,8x1,8x11,2 cm
		4 pcs = 1 set
		10 sets
EAN		5905167736937

SYMBOLS



100% WATERPROOF
Clean your floor without any risk – non-deforming, water resistant board!



FLEXIBLE
Flexible adaptation to uneven walls.



IMPACT RESISTANT
Highest resistance and stability.

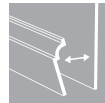

EASY WALL RENOVATION
Possibility of unfixing skirtings in order to paint or hide TV or audio cable (max 230V).



KEEP IT WHITE OR PAINT IT
The board which can be painted. Possibility of fully matching the board colours to the walls of the room.



4 WAY SYSTEM
Solid, fast, simple installation and deinstallation, for any type of wall.



GLOSSY SURFACE
Brilliant shiny finishing.

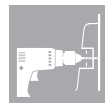

EASY INSTALLATION
Wide installation channel provides an easy access for a drill or screwdriver. It makes installation quicker and easier.



WOOD EFFECT
The ideal colour and design match, 100% accurate representation of wooden colors.



MITRE SAW
The possibility of cutting corners with a mitre saw.



MANUAL CUTTING
The possibility of cutting corners with a hand saw.



DUST AND DIRT BARRIER
Smooth surface without micropores and harder COEX is perfect for easy cleaning and non adhering dirt and dust.



CLICK OR GLUE
Install the skirting in two ways: glue skirting directly to the wall, or clip - strip easily and remove at any time.



MODERN DESIGN
Unique shape was created for a modern interiors and its simplicity is an answer even for the most demanding.



WOOD STRUCTURE
Structure embossed on the surface, perfectly imitating the real wood.



JUST GLUE
Glue skirting directly to the wall.



DEEP MATT

Thanks to totally new, multi-step process of production we get a deep matt surface.



SUPER FLEXIBLE

Flexible adaptation to uneven walls.



GLUING CHANNEL

special glue channel to prevent the excess of glue from slipping out.



NO SILICONE NEEDED

Integrated and large rubber edges in the color of the skirting adapts to uneven surfaces and gives a solid connection with the wall and the floor resulting in 100% waterproof barrier

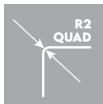

R2 DESIGN = 2mm



DIGITAL DESIGN

Due to the highly advanced technology of digital printing - piezoelectric UV LED with high-resolution (up to 1800 dpi)



HYBRID
TECHNOLOGY

HYBRID TECHNOLOGY

The product that combines the advantages of polymer products, like impact resistance and waterproof with high quality surface of lacquered MDF skirtings.



ECO FRIENDLY

The board made of environmentally friendly material.



100% PVC FREE

The board made of environmentally friendly material.



MDF

Skirting board made from MDF covered with coated paper which increases durability. It's not necessary to paint the skirting board before the first installation.



PATENTED

Our technology is patented



The materials awarded this label comply with very stringent health and environmental requirements.



The materials awarded this label comply with very stringent health and environmental requirements.

Arbiton
FLOOR EXPERT

Decora S.A.
ul. Prądyńskiego 24a
63-000 Środa Wlkp., Polska
tel.: +48 61 28 64 200
fax: +48 61 28 54 975
e-mail: sales@decora.pl
www.arbiton.com

CHECK OUR COMPLEMENTARY PRODUCTS



The catalogue is a free of charge presentation of products of Decora S.A. and acc. to valid law it is not a commercial offer. Colors and textures of the products in pictures may differ from real ones because of limited printing technologies. Decora S.A. reserves its right to alter availability of the products on some markets and at some distributors. The products included in the catalogues do not pose a complete offer of Decora S.A.

